

**Sample Order / Cheat Sheet**  
**N Window Hardware 1/2**

QUOTE     ORDER

NAME: \_\_\_\_\_

PO# \_\_\_\_\_

ADDRESS: \_\_\_\_\_

DELIVERY: \_\_\_\_\_

ADDRESS: \_\_\_\_\_

ADDRESS: \_\_\_\_\_



ORDER DATE: \_\_\_\_\_

OFFICE PHONE: \_\_\_\_\_

CONTACT: \_\_\_\_\_

FAX PHONE: \_\_\_\_\_

JOB NAME: \_\_\_\_\_

JOB PHONE: \_\_\_\_\_

**HARDWARE WORK ORDER**  
 Toll Free 888.788.2013 or 208.788.2013; Fax 208.788.2577

301012

LINE NO.	FUNCTION	HANDLE		ESCUTCHEON		METAL	PATINA	HANDING OR LENGTH	BACKSET	DOOR THICKNESS	LOCK TYPE	DEAD BOLT TRIM	DESCRIPTION	LOCATION #	QTY.	PRICE QUOTED
		EXTERIOR	INTERIOR	EXTERIOR	INTERIOR											
1	WN	LW40		EW105		B	D	R		214					1	186.00
2	AC					B	L	R					WC200		1	165.00
3	AC					W	L						WC100		1	160.00
4	LC	LC300				W	D	R					LC305		1	274.00
5	AC					B	M						SL100		1	99.00

**FUNCTION**

AC = Accessory  
 CA = Casement Adjuster  
 LC = Casement Latch  
 WN = Window Trim Set

**HANDLE**

For a list of Levers available for Window Hardware, see next page.  
 For specifications, refer to Section A.

**ESCUTCHEONS**

For a list of Escutcheons available for Window Hardware, see next page.  
 For configurations, specifications, and pricing, refer to content of this section.

**METAL**

B = Silicon Bronze  
 W = White Bronze

**PATINA**

L = Light  
 M = Medium  
 D = Dark  
 R = Rust  
 BB = Brushed  
 DL = Dark Lustre

**HANDING / LENGTH**

See Hinged Door Handing diagram, next page.

L = Left Hand  
 R = Right Hand  
 LR = Left Hand Reverse  
 RR = Right Hand Reverse

Casement Adjuster lengths:  
 10"  
 12"  
 14"  
 20"

**BACKSET**

Not Applicable

**DOOR THICKNESS**

138 = 1 3/8"  
 112 = 1 1/2"  
 134 = 1 3/4"  
 178 = 1 7/8"  
 2 = 2"  
 214 = 2 1/4"  
 212 = 2 1/2"  
 258 = 2 5/8"  
 234 = 2 3/4"  
 3 = 3"

Up-charge for sizes below.

Call for pricing.  
 314 = 3 1/4"  
 312 = 3 1/2"  
 4 = 4"  
 N = No

**LOCK TYPE**

Not Applicable

**DEAD BOLT TRIM**

Not Applicable

**DESCRIPTION**

For a list of available descriptions, see next page.

**LOCATION #**

**QTY**

Number of each desired

**PRICE**

\$ List price each

**HANDLES**

- LW05 = Mini Ellis Lever
- LW10 = Mini Euro Lever
- LW20 = Mini French Lever
- LW33 = Mini Reed Lever
- LW37 = Mini Strap Lever
- LW40 = Mini Classic Lever
- LW50 = Mini Acanthus Lever
- LW60 = Mini Harrington Lever
- LW63 = Mini Olympus Lever
- LW65 = Mini Falcon Lever
- LW80 = Mini Monarch Lever
- L104 = Hook Lever
- T300 = T Handle
- LC300 = Casement Latch Lever

**ESCUTCHEONS**

**Rectangular**

- EW101 = 1 1/4" x 3" Rect (WE)
- EW103 = 1 3/8" x 4 1/2" Rect (WE)
- EW105 = 1 1/2" x 3" Rect (WE)
- EW108 = 1 1/2" x 4 1/2" Rect (WE)

**Stepped**

- EW308 = 1 1/2" x 4 1/2" Stepped (WE)

**Metro**

- EW225 = 1 1/4" x 4 1/2" Metro (WE)
- EW202 = 1 1/2" x 4 1/2" Metro (WE)

**Curved**

- EW507 = 1 1/4" x 4 1/2" Curved (WE)
- EW501 = 1 3/8" x 4 1/2" Curved (WE)
- EW508 = 1 1/2" x 4 1/2" Curved (WE)

**Arched**

- EW720 = 1 3/16" x 3 3/4" Arched (WE)
- EW707 = 1 3/8" x 4 1/2" Arched (WE)
- EW705 = 1 1/2" x 3" Arched (WE)
- EW708 = 1 1/2" x 4 1/2" Arched (WE)

**Ellis**

- EW005 = 1 1/2" x 4 1/2" Ellis (WE)

**Convex**

- EW30500 = 1 1/2" x 3 3/4" Convex (WE)

**Corbel Arched**

- EW30600 = 1 1/2" x 3 3/4" Corbel Arched (WE)

**Corbel Rectangular**

- EW30700 = 1 1/2" x 3 3/4" Corbel Rect (WE)

**Key**

(WE) = Window Escutcheon

**DESCRIPTION**

- LC303 = Mortise Strike
- LC305 = Universal Strike
- LC307 = Surface Strike
- SFP100 = Sash Lift
- SL100 = Sash Lock
- DHSL100 = Double-Hung Sash Lock
- DHSL200 = Double-Hung Sash Lock
- DHSL700 = Double-Hung Sash Lock
- ULL200 = Sash Lock (Pella)
- LC500 = Sash Lock (Loewen)
- LC510 = Sash Lock (Truth)
- LC600 = Sash Lock (Truth)
- LC730 = Sash Lock (Sierra Pacific)
- LC710 = Tilt Lock (Sierra Pacific)
- WC100 = Truth Window Crank & Cover
- WC140 = Marvin Window Crank & Cover
- WC141 = Marvin Window Crank & Cover
- WC160 = Truth Window Crank & Cover
- WC200 = Pella Window Crank & Cover
- WC400 = Marvin Window Crank & Cover
- WC450 = Truth Window Crank & Cover
- WL10 = Sash Lock (Marvin)
- WL180 = Sash Lock (Marvin)
- WL210 = Sash Lock (Marvin)
- WL211 = Sash Lock (Marvin Dummy)
- WD10 = Sash Lock (Marvin)
- WD130 = Sash Lock (Marvin)
- WSL10 = Sash Lift (Marvin)
- WSL20 = Sash Lift (Marvin)
- WSL40 = Sash Lift (Marvin)

**HANDING**

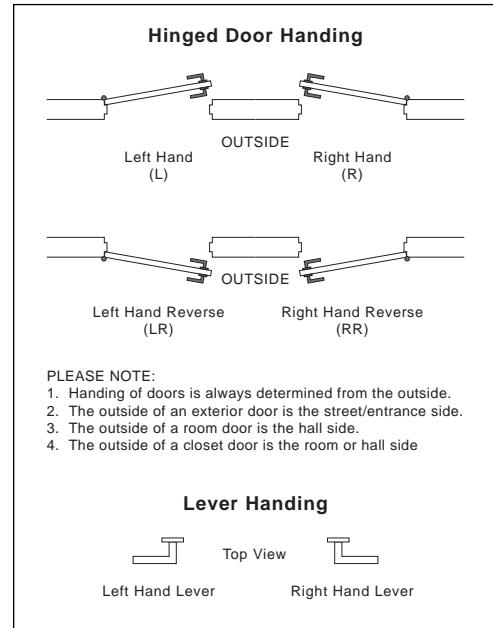

- All finishes are priced the same.
- Price includes your choice of any lever. Call for pricing.
- Combinations are shown with L104 Hook Lever for illustrations only. Refer to Section A for desired lever.
- Specify metal, patina, sash thickness, handing, screws, spindle length, and type of window designed for.
- Supplied with M5 x .8 x 40 mm screws and 7 mm spindle unless otherwise specified.
- Levers index at 3, 6, 9, and 12 o'clock positions.

**Window Trim Sets**

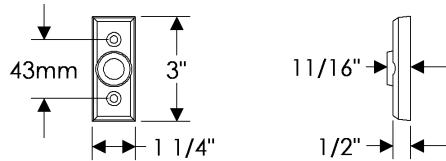

**EW101** Rectangular Window Escutcheon  
1 1/4" x 3" ..... \$ 314.00

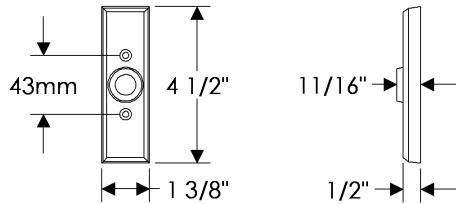

**EW103** Rectangular Window Escutcheon  
1 3/8" x 4 1/2" ..... \$ 314.00

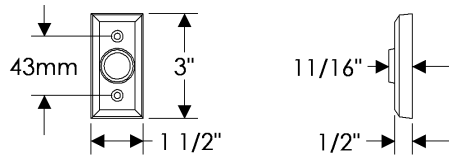

**EW105** Rectangular Window Escutcheon  
1 1/2" x 3" ..... \$ 186.00

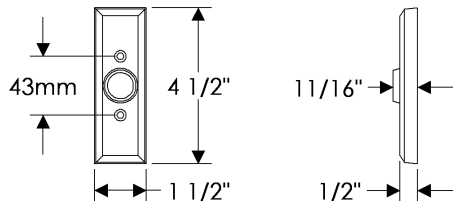

**EW108** Rectangular Window Escutcheon  
1 1/2" x 4 1/2" ..... \$ 196.00

- All finishes are priced the same.
- Price includes your choice of any lever. Call for pricing.
- Combinations are shown with L104 Hook Lever for illustrations only. Refer to Section A for desired lever.
- Specify metal, patina, sash thickness, handing, screws, spindle length, and type of window designed for.
- Supplied with M5 x .8 x 40 mm screws and 7 mm spindle unless otherwise specified.
- Levers index at 3, 6, 9, and 12 o'clock positions.

**Window Trim Sets**

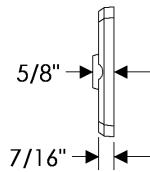
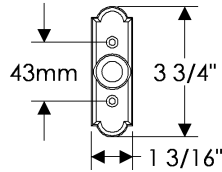

**EW720** Arched Window Escutcheon  
1 3/16" x 3 3/4" ..... \$ 314.00

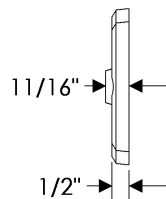
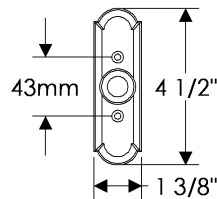

**EW707** Arched Window Escutcheon  
1 3/8" x 4 1/2" ..... \$ 314.00

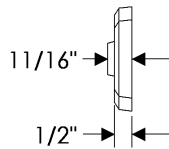
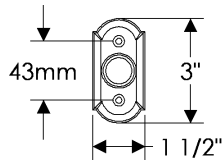

**EW705** Arched Window Escutcheon  
1 1/2" x 3" ..... \$ 186.00

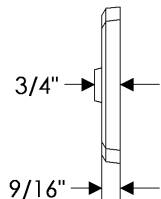
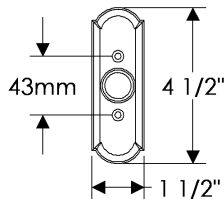

**EW708** Arched Window Escutcheon  
1 1/2" x 4 1/2" ..... \$ 196.00

- All finishes are priced the same.
- Price includes your choice of any lever. Call for pricing.
- Combinations are shown with L104 Hook Lever for illustrations only. Refer to Section A for desired lever.
- Specify metal, patina, sash thickness, handing, screws, spindle length, and type of window designed for.
- Supplied with M5 x .8 x 40 mm screws and 7 mm spindle unless otherwise specified.
- Levers index at 3, 6, 9, and 12 o'clock positions.

**Window Trim Sets**

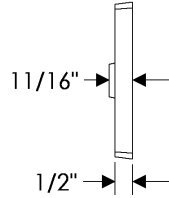
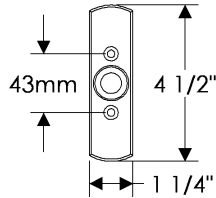

**EW507** Curved Window Escutcheon  
1 1/4" x 4 1/2" ..... \$ 314.00

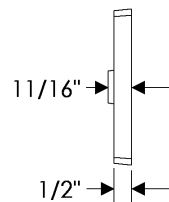
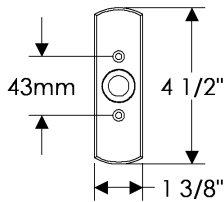

**EW501** Curved Window Escutcheon  
1 3/8" x 4 1/2" ..... \$ 314.00

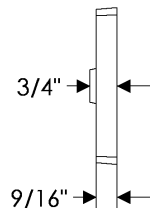
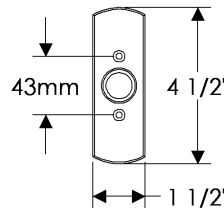

**EW508** Curved Window Escutcheon  
1 1/2" x 4 1/2" ..... \$ 196.00

- All finishes are priced the same.
- Price includes your choice of any lever. Call for pricing.
- Combinations are shown with L104 Hook Lever for illustrations only. Refer to Section A for desired lever.
- Specify metal, patina, sash thickness, handing, screws, spindle length, and type of window designed for.
- Supplied with M5 x .8 x 40 mm screws and 7 mm spindle unless otherwise specified.
- Levers index at 3, 6, 9, and 12 o'clock positions.

**Window Trim Sets**

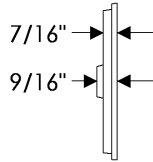
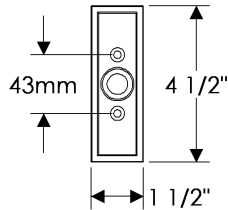

**EW308 Stepped Window Escutcheon**  
 1 1/2" x 4 1/2" ..... \$ 314.00

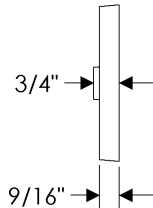
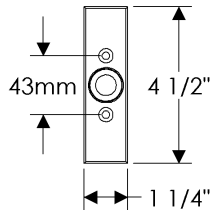

**EW225 Metro Window Escutcheon**  
 1 1/4" x 4 1/2" ..... \$ 314.00

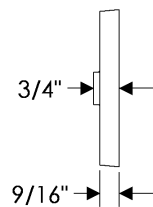
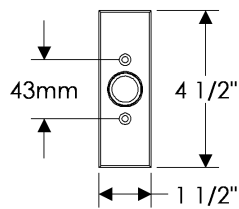

**EW202 Metro Window Escutcheon**  
 1 1/2" x 4 1/2" ..... \$ 196.00

- All finishes are priced the same.
- Price includes your choice of any lever. Call for pricing.
- Combination is shown with LW05 Mini Ellis Lever for illustrations only. Refer to Section A for desired lever.
- Specify metal, patina, sash thickness, handing, screws, spindle length, and type of window designed for.
- Supplied with M5 x .8 x 40 mm screws and 7 mm spindle unless otherwise specified.
- Levers index at 3, 6, 9, and 12 o'clock positions.

**Window Trim Sets**

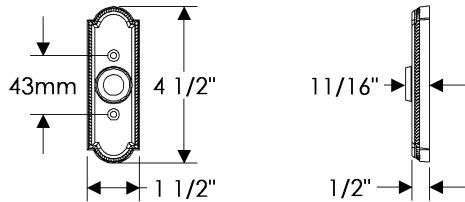

**EW005** Ellis Window Escutcheon  
 1 1/2" x 4 1/2" ..... \$ 340.00

- All finishes are priced the same.
- Price includes your choice of any lever. Call for pricing.
- Combination is shown with L104 Hook Lever for illustrations only. Refer to Section A for desired lever.
- Specify metal, patina, sash thickness, handing, screws, spindle length, and type of window designed for.
- Supplied with M5 x .8 x 40 mm screws and 7 mm spindle unless otherwise specified.
- Levers index at 3, 6, 9, and 12 o'clock positions.

**Window Trim Sets**

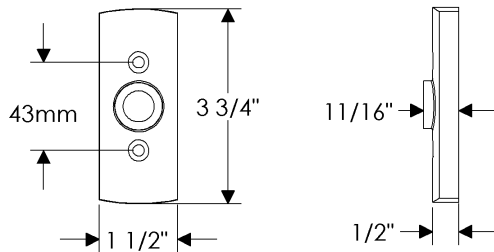

**EW30500** Convex Window Escutcheon  
1 1/2" x 3 3/4" ..... \$ 340.00

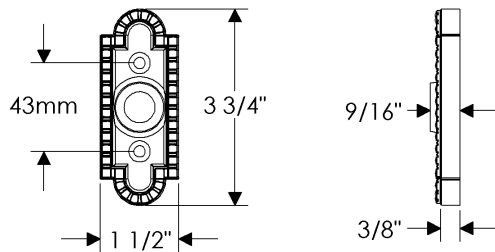

**EW30600** Corbel Arched Window Escutcheon  
1 1/2" x 3 3/4" ..... \$ 340.00

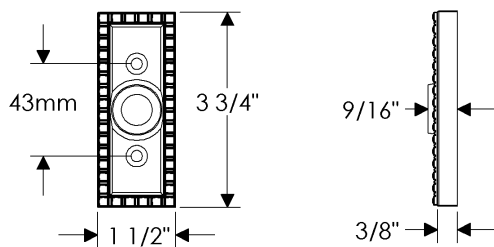

**EW30700** Corbel Rectangular Window Escutcheon  
1 1/2" x 3 3/4" ..... \$ 340.00



- All finishes are priced the same.
- Specify metal, patina, sash thickness, handing, screws, spindle length, and type of window designed for.
- Supplied with #10-32 x 1" screws and 7 mm spindle unless otherwise specified.

**Window Trim Sets**

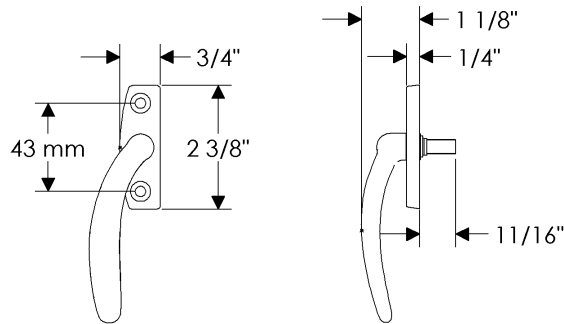

**WL210 Sash Lock**  
 3/4" x 2 3/8" ..... \$ 196.00

**WL211 Sash Lock - Dummy**  
 3/4" x 2 3/8" ..... \$ 196.00

- \* Designed for Marvin push out
- \* Left hand shown

- All finishes are priced the same.
- Specify metal and patina (and handing for the WC140 and WC141 series).

**Window Cranks**

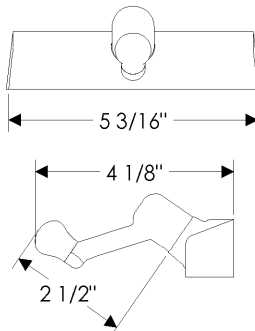
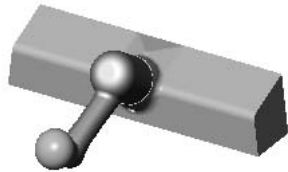

Casement Window Hardware\*

**WC100** Crank & Cover . . . . . \$ 160.00

- \* Designed for Truth Entry Guard.
- \* Can be modified for compatibility with Ashland Mechanisms. Call for pricing.

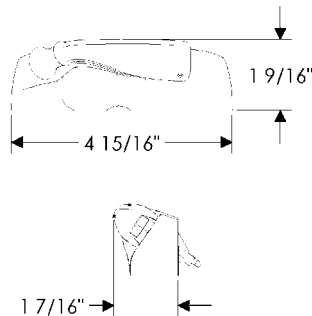

Casement Window Hardware\*

**WC140** Crank & Cover . . . . . \$ 246.00

- \* Designed for Marvin Ultimate Case Master
- \* For handing examples, see image below.

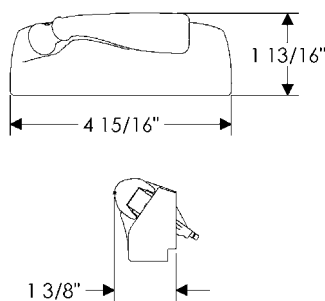
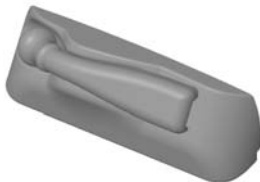

Casement Window Hardware\*

**WC141** Crank & Cover . . . . . \$ 246.00

- \* Designed for Marvin Ultimate Replacement Case Master
- \* For handing examples, see image below.

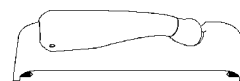

LEFT HAND COVER (L)

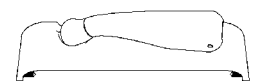

RIGHT HAND COVER (R)

- All finishes are priced the same.
- Specify metal, patina, and handing.

**Window Cranks**

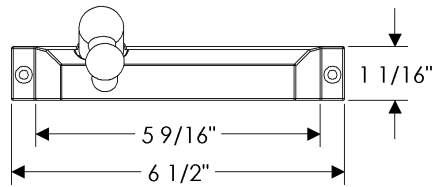
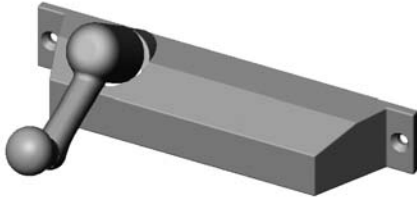

Casement Window Hardware\*

**WC160** Crank & Cover . . . . . \$ 165.00

\* Specify Truth Encore or Truth Maxim

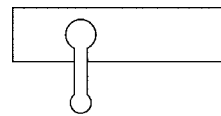

LEFT HAND WINDOW (L)

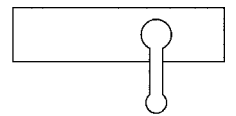

RIGHT HAND WINDOW (R)

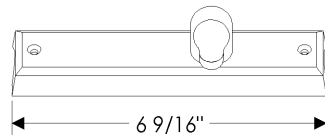
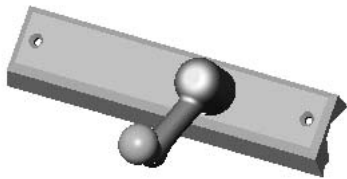
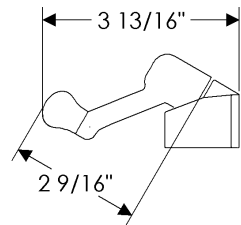

Casement Window Hardware\*

**WC200** Crank & Cover . . . . . \$ 165.00

\* Designed for Pella Architect and Designer Series models.

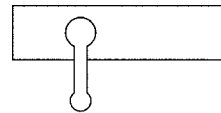
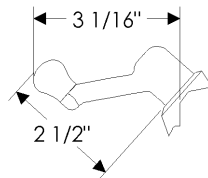

LEFT HAND WINDOW (L)

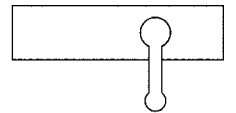

RIGHT HAND WINDOW (R)

- All finishes are priced the same.
- Specify metal, patina, and handing.

**Window Cranks**

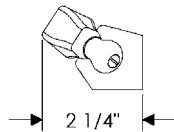
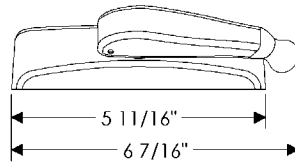

Casement Window Hardware\*

**WC400** Crank & Cover . . . . . \$ 246.00

- \* Designed for Truth Entry Guard.
- \* Can be modified for compatibility with Ashland Mechanisms. Call for pricing.
- \* For handing examples, see image below.

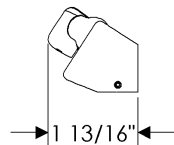
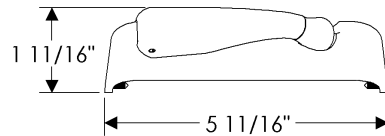
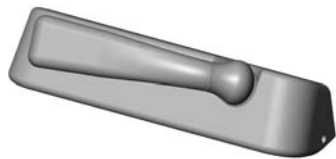

Casement Window Hardware\*

**WC450** Crank & Cover . . . . . \$ 246.00

- \* Designed for Truth Encore.
- \* For most situations a left hand cover will work with a left hand window. Narrow windows may be an exception. Verify cover handing with images below.
- \* For handing examples, see image below.

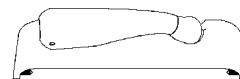

LEFT HAND COVER (L)

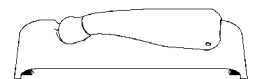

RIGHT HAND COVER (R)

- All finishes are priced the same.
- Specify metal, patina, and handing.

**Casement Latches**

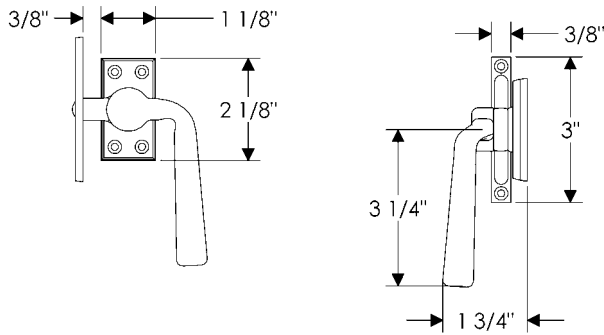

**LC300 Casement Latch**  
with **LC303 Mortise Strike** . . . . . \$ 262.00

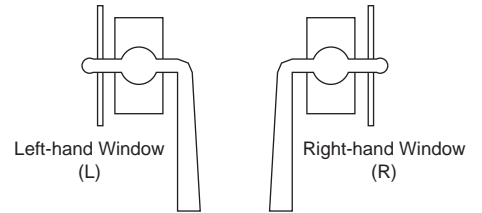

- Optional strike: **LC307**

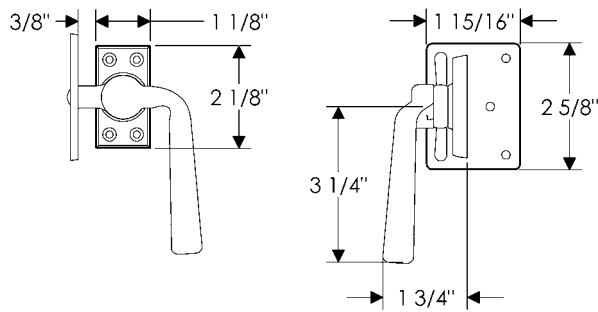
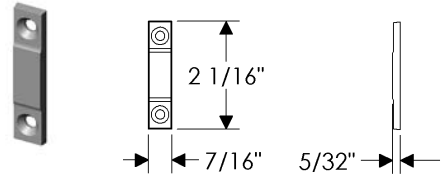

**LC300 Casement Latch**  
with **LC305 Universal Strike** . . . . . \$ 274.00

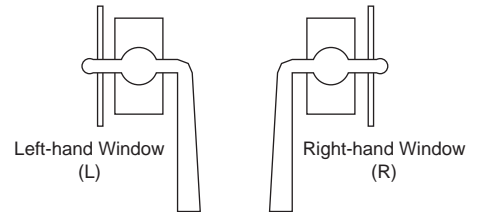

- Optional strike: **LC307**

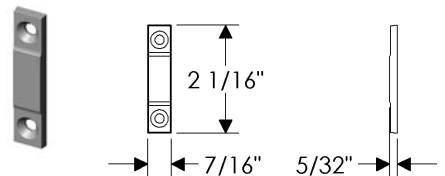

- All finishes are priced the same.
- Specify metal and patina (and handing for the ULL200 Sash Lock).

**Sash Lifts**

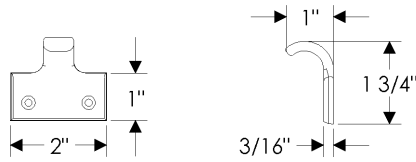

**SFP100** Sash Lift . . . . . \$ 42.00

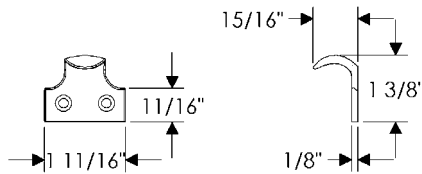

**WSL20** Sash Lift . . . . . \$ 39.00

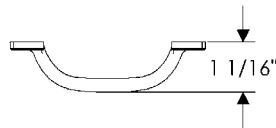
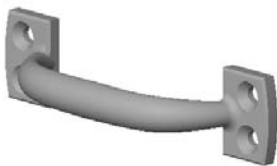

**WSL10** Double-Hung Sash Lift . . . . . \$ 50.00

\* Compatible with Marvin Ultimate double hung.

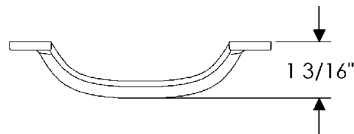
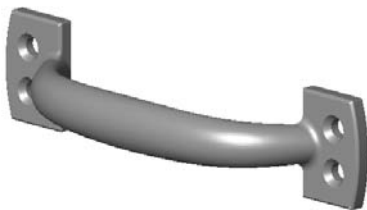
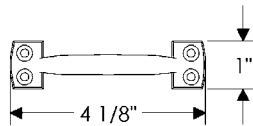

**WSL40** Double-Hung Sash Lift . . . . . \$ 85.00

\* Compatible with Marvin Ultimate double hung magnum.

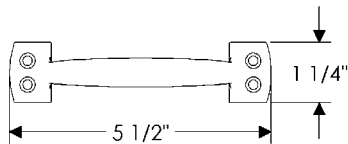

- All finishes are priced the same.
- Specify metal and patina (and handing for the ULL200 Sash Lock).

**Sash Locks**

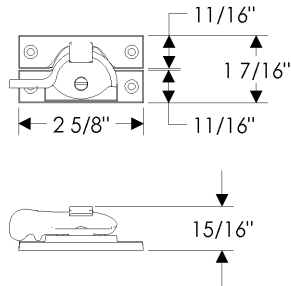

**SL100 Sash Lock** ..... \$ 99.00

- Optional strike: **SLK105**

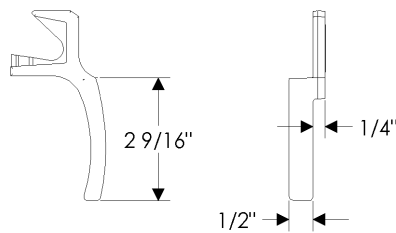
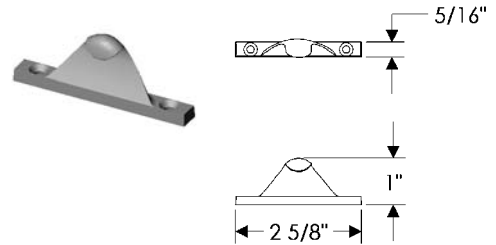

**ULL200 Sash Lock\*** ..... \$ 49.00

- \* Designed for Pella windows.  
Call for compatibility.

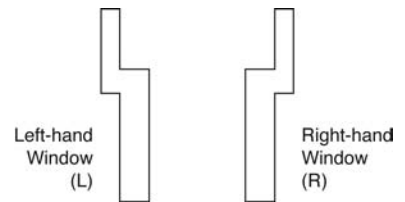

- All finishes are priced the same.
- Specify metal and patina.

**Sash Locks**

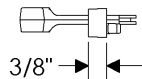
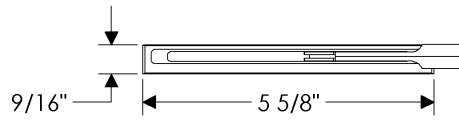

**LC730 Sash Lock\*** . . . . . \$ 278.00

- \* Designed for Sierra Pacific windows.
- \* Use in conjunction with WC450.

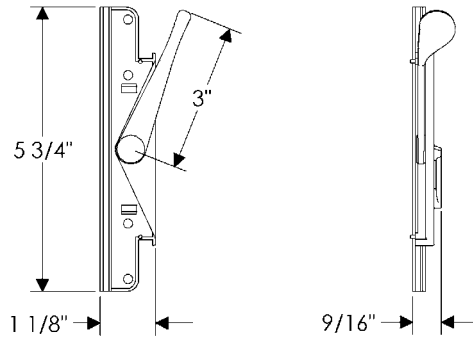

**WL10 Sash Lock\*** . . . . . \$ 303.00

- \* Designed for Marvin Casemaster windows.
- Call for compatibility.

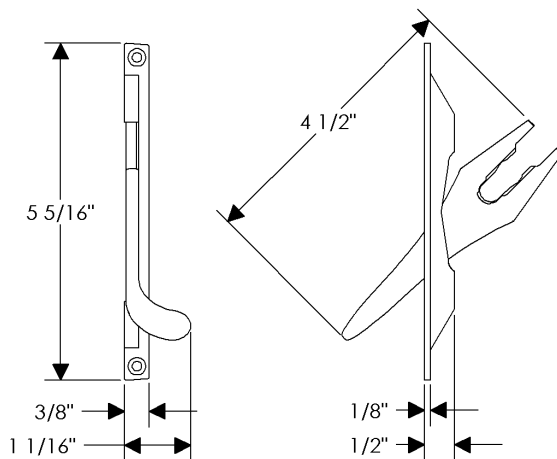

**LC500 Sash Lock\*** . . . . . \$ 278.00

- \* Designed for Truth Mirage Concealed Multi-point Locking Systems.



- All finishes are priced the same.
- Specify metal and patina.

**Sash Locks**

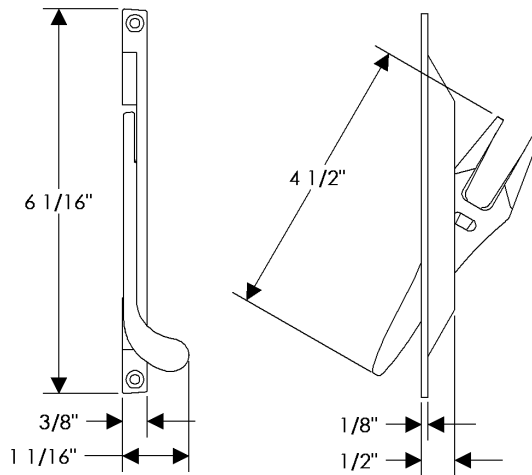

**LC510 Sash Lock\*** ..... \$ 278.00

\* Designed for Ashland Multi-point Casement Locks.

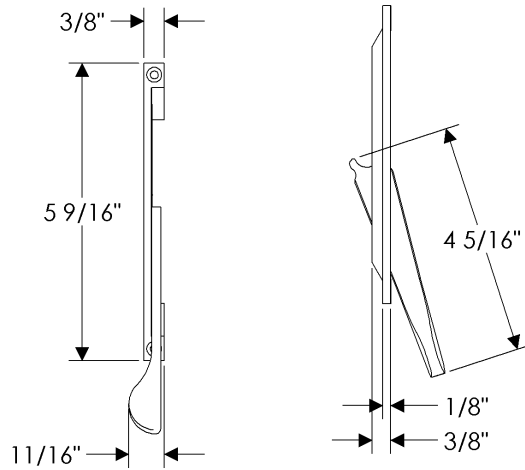

**LC600 Sash Lock\*** ..... \$ 278.00

\* Designed for Truth Encore Multi-point Casement Locks.

\* Field modifications required, call for specifications.

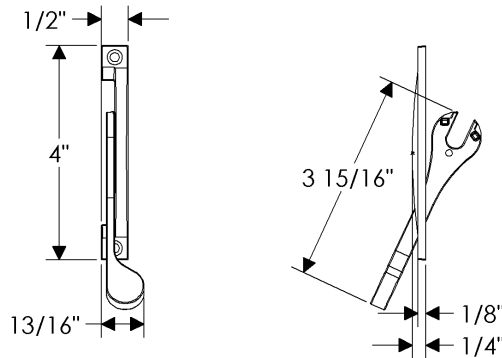

**WL180 Sash Lock\*** ..... \$ 278.00

\* Designed for Marvin Ultimate Casemaster.

- All finishes are priced the same.
- Specify metal and patina.

**Double-Hung Sash Lock**

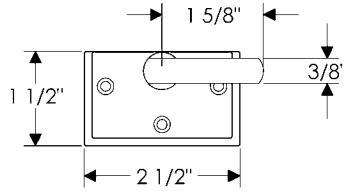
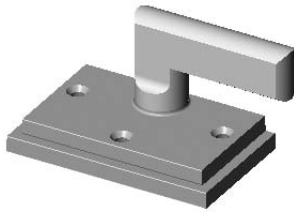

**DHSL100** Double-Hung Sash Lock . . \$ 132.00

- Compatible with Pella Model 2 Architect series windows
- Includes strike (not pictured)

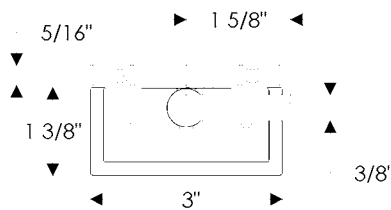
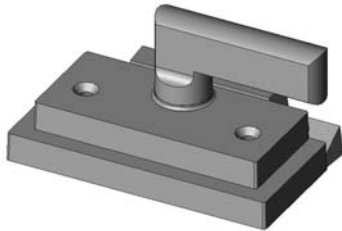
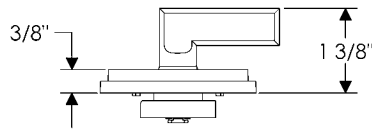

**DHSL200** Double-Hung Sash Lock . . \$ 181.00

- Compatible with Pella Model 3 Architect series windows
- Includes bronze strike



- All finishes are priced the same.
- Specify metal and patina.

**Double-Hung Sash Lock**

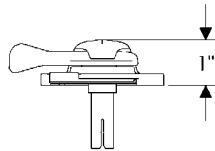
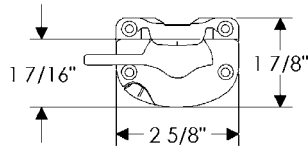

**WD10** Double-Hung Sash Lock . . . . \$ 229.00

- Compatible with Marvin Ultimate double hung

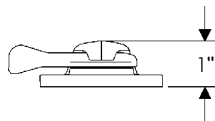
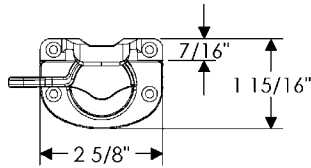

**WD130** Double-Hung Sash Lock . . . . \$ 214.00

- Compatible with Marvin Ultimate double hung magnum

- All finishes are priced the same.
- Specify metal and patina.

**Double-Hung Sash Lock**

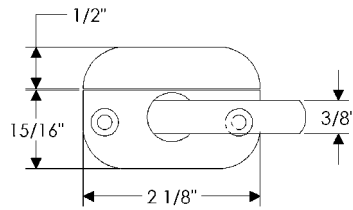

**DHSL700** Double-Hung Sash Lock . . . \$ 181.00

- Designed for Sierra Pacific
- Includes bronze strike
- Used in conjunction with LC710 Tilt Lock

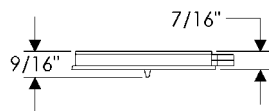
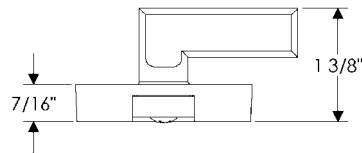

**LC710** Tilt Lock . . . . . \$ 171.00

- Designed for Sierra Pacific
- Used in conjunction with DHSL700 Double Hung Sash Lock

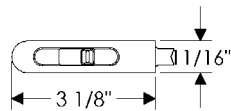

- All finishes are priced the same.
- Specify metal and patina.

**Casement Adjusters**

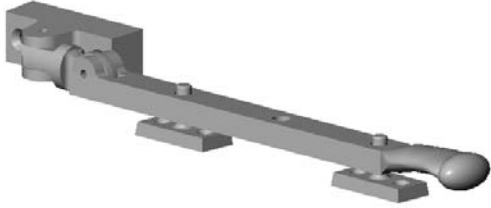

**CA10** Casement Adjuster . . . . . \$ 291.00

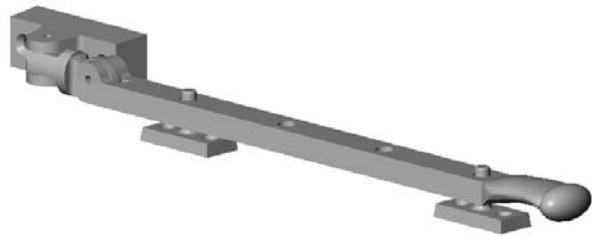
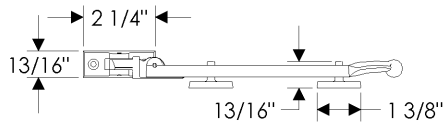
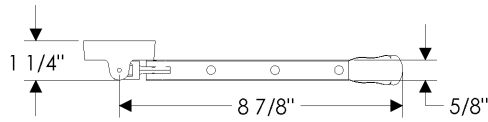

**CA12** Casement Adjuster . . . . . \$ 295.00

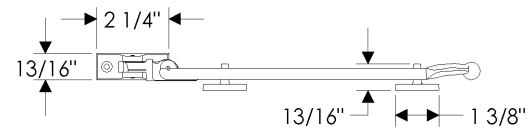
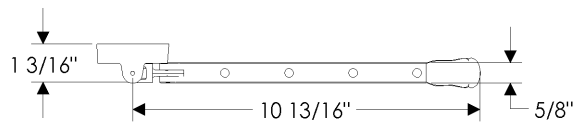

- All finishes are priced the same.
- Specify metal and patina.

**Casement Adjusters**

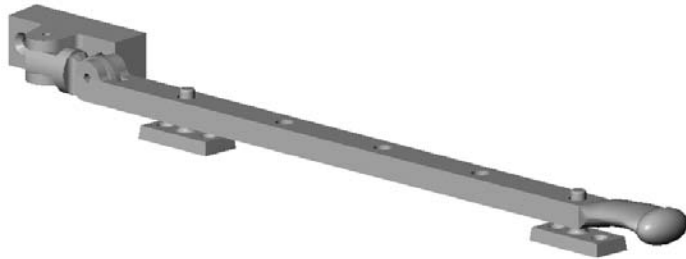

**CA14** Casement Adjuster . . . . . \$ 300.00

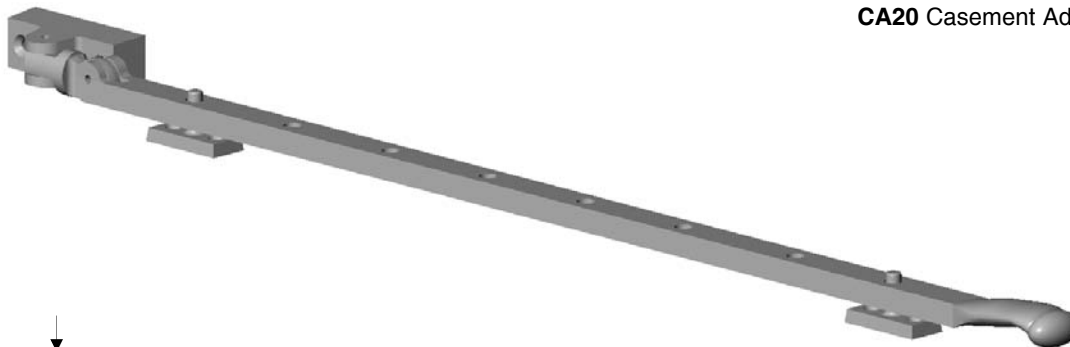
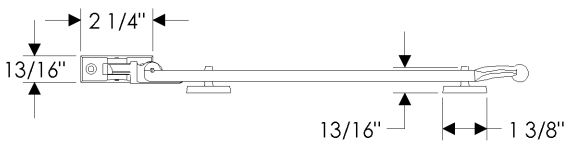
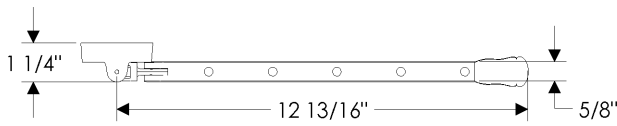

**CA20** Casement Adjuster . . . . . \$ 346.00

