

LCN®

Price book 6

Effective July 7, 2018 - Rev. 12/18

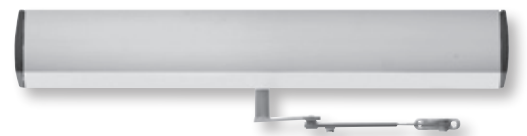
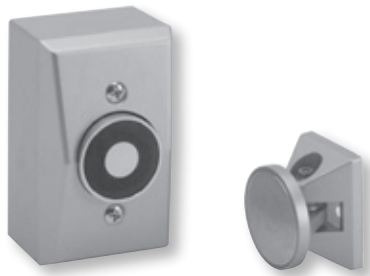

COMPLETE DOOR CLOSERS

PRICE LIST

CLOSER SERIES		STANDARD POWDER COAT FINISHES	PLATED FINISHES			S H E E T P I N G	 July 2018
SERIES NUMBER	ARM TYPE	AL (689) DKBRZ (695) BRASS (696) LTBRZ (691) STAT (690) BLACK (693)	US26D	US 3 US 4 US 10	US 11 US 15 US 26		

1250 Series - Surface Mount

1250Rw/PA*	\$205	N/A	N/A	8
1250Rw/62A	220	N/A	N/A	7
1250 LONG	205	N/A	N/A	7
1250Hw/PA*	235	N/A	N/A	10
1250HLONG	235	N/A	N/A	10
1250EDA	255	N/A	N/A	8
1250HEDA (Handed)	290	N/A	N/A	8
1250CUSH	290	N/A	N/A	9
1250HCUSH	350	N/A	N/A	9
1250SCUSH	350	N/A	N/A	9
1250SHCUSH	410	N/A	N/A	9

Add for; Slim Cover (**SLIM**) (\$15), Custom Powder Finish (**RAL**) (\$40), Brite Metallic (**MTLPC**) (\$60), TORX Fasteners (**TORX**) (\$15), Special Rust Inhibitor (**SRI**) (\$40)

*Note - When BAA (Buy American Act) is required for 1250 Rw/PA and Hw/PA in AL or DKBRZ please designate BAA when ordering.

Buy American Act (BAA) (\$30) for 1250 Rw/PA and Hw/PA in AL or DKBRZ.

For parts & accessories, see page 50

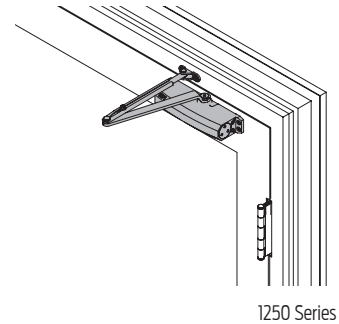

1250 Series

1260 Series - Surface Mount

1261 REG	\$266	N/A	N/A	11
1261 Rw/PA	271	N/A	N/A	12
1261Rw/62A	287	N/A	N/A	12
1261 LONG	271	N/A	N/A	11
1261 H	298	N/A	N/A	11
1261Hw/PA	303	N/A	N/A	12
1261HLONG	303	N/A	N/A	11
1261EDA	324	N/A	N/A	13
1261EDA w/62G	330	N/A	N/A	13
1261HEDA (Handed)	356	N/A	N/A	13
1261 HEDA w/62G (Handed)	362	N/A	N/A	13
1261CUSH	356	N/A	N/A	12
1261HCUSH	415	N/A	N/A	12

Add for; Slim Cover (**SLIM**) (\$16), TORX Fasteners (**TORX**) (\$15), Special Rust Inhibitor (**SRI**) (\$40)

For parts & accessories, see page 50.

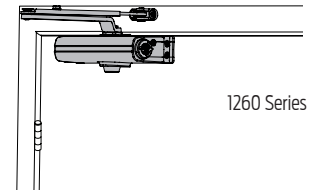

1260 Series

COMPLETE DOOR CLOSERS

PRICE LIST

CLOSER SERIES		STANDARD POWDER COAT FINISHES	PLATED FINISHES			S H E I P P I N G	 July 2018
SERIES NUMBER	ARM TYPE	AL (689) DKBRZ (695) BRASS (696) LTBRZ (691) STAT (690) BLACK (693)	US26D	US 3 US 4 US 10	US 11 US 15 US 26		

1450 Series - Surface Mount

1450	Rw/PA*	\$275	N/A	N/A	9
1450	Rw/62A	290	N/A	N/A	9
1450	LONG	275	N/A	N/A	8
1450	Hw/PA*	305	N/A	N/A	11
1450	HLONG	305	N/A	N/A	11
1450	EDA	325	N/A	N/A	9
1450	EDA w/62G	330	N/A	N/A	9
1450	HEDA	360	N/A	N/A	9
1450	CUSH	360	N/A	N/A	9
1450	HCUSH	420	N/A	N/A	10
1450	SCUSH	420	N/A	N/A	10
1450	SHCUSH	480	N/A	N/A	10

Add for; Delay Action (**DEL**) (\$42), Full Metal Cover (**MC**) (\$30), Full Plastic Cover (**FC**) (\$10), TORX Fasteners (**TORX**) (\$15), Custom Powder Finish (**RAL**) (\$40), Brite Metallic (**MTLPC**) (\$60), Special Rust Inhibitor (**SRI**) (\$40)

*Note - When BAA (Buy American Act) is required for 1450 Rw/PA and Hw/PA in AL or DKBRZ please designate BAA when ordering.
Buy American Act (BAA) (\$30) for 1450 Rw/PA and Hw/PA in AL or DKBRZ.

For parts & accessories, see page 50.

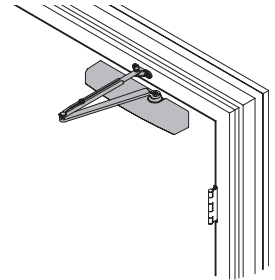

1450 Series

1450T Series - Surface Mount (Coming Soon)

1450T	STD	\$360	NA	NA	12
1450T	H	382	NA	NA	12
1450T	BUMPER	392	NA	NA	12
1450T	H BUMPER	390	NA	NA	12

Add for; Full Metal Cover (**MC**) (\$30), Full Plastic Cover (**FC**) (\$10), TORX Fasteners (**TORX**) (\$15), Special Rust Inhibitor (**SRI**) (\$40), Custom Powder Finish (**RAL**) (\$40), Brite Metallic (**MTLPC**) (\$60)

1460 Series - Surface Mount

1461	REG	\$341	\$614	\$686	9
1461	Rw/PA	346	668	756	11
1461	Rw/62A	372	686	771	11
1461	LONG	346	617	691	9
1461	H	373	628	705	10
1461	Hw/PA	378	681	777	11
1461	HLONG	378	631	713	10
1461	HD	373	644	724	9
1461	HD/PA	378	704	792	11
1461	HDw/62A	394	724	811	11
1461	HD/LONG	378	654	729	10
1461	EDA	399	750	826	12
1461	EDA w/62G	405	756	830	12
1461	HEDA (Handed)	431	782	861	12
1461	HEDA w/62G (Handed)	437	793	857	12
1461	CUSH	431	793	861	11
1461	HCUSH	490	830	915	11
1461	SCUSH	490	830	915	11
1461	SHCUSH	531	860	942	11

Add for; Delay Action (**DEL**) (\$42), Designer Series Cover (**DS**) (\$32), Full Cover (**FC**) (\$11), TORX Fasteners (**TORX**) (\$15), Special Rust Inhibitor (**SRI**) (\$40), Custom Powder Finish (**RAL**) (\$40), Brite Metallic (**MTLPC**) (\$60)

For parts & accessories, see page 51.

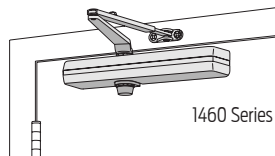

1460 Series

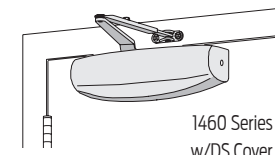

1460 Series
w/DS Cover

1460T Series - Surface Mount

1460T, 1461T	STD	\$427	\$693	\$720	12
1460T, 1461T	H	448	714	791	12
1460T, 1461T	BUMPER	437	703	780	12
1460T, 1461T	H BUMPER		725	802	12

Add for; Designer Series Cover (**DS**) (\$32), Full Cover (**FC**) (\$11), TORX Fasteners (**TORX**) (\$15), Special Rust Inhibitor (**SRI**) (\$40), Custom Powder Finish (**RAL**) (\$40), Brite Metallic (**MTLPC**) (\$60)

For parts & accessories, see page 51.

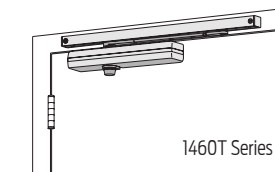

1460T Series

 Indicates products that have EPD documentation available and meet LEED v4.

COMPLETE DOOR CLOSERS

PRICE LIST

CLOSER SERIES		STANDARD POWDER COAT FINISHES	PLATED FINISHES			S H E E T P I P H T G	
SERIES NUMBER	ARM TYPE	AL (689) DKBRZ (695) BRASS (696) LTBRZ (691) STAT (690) BLACK (693)	US26D	US 3 US 4 US 10	US 11 US 15 US 26		

4050 Series - Surface Mount

4050.....Rw/PA	\$435	N/A	N/A	13
4050.....LONG	435	N/A	N/A	14
4050.....Rw/62A	455	N/A	N/A	13
4050.....Hw/PA	475	N/A	N/A	12
4050.....HLONG	475	N/A	N/A	12
4050.....EDA	465	N/A	N/A	14
4050.....EDA w/62G	470	N/A	N/A	13
4050.....HEDA (handed)	495	N/A	N/A	14
4050.....HEDA w/62G (handed)	500	N/A	N/A	13
4050.....CUSH	495	N/A	N/A	14
4050.....HCUSH	555	N/A	N/A	14
4050.....SCUSH	555	N/A	N/A	15
4050.....SHCUSH	615	N/A	N/A	15

Add for; Delay Action (**DEL**) (\$43), Metal Cover (**MC**) (\$10), TORX Fasteners (**TORX**) (\$15), Custom Powder Finish (**RAL**___) (\$40), Brite Metallic (**MTLPC**) (\$60), Special Rust Inhibitor (**SRI**) (\$40).
For parts & accessories, see page 57.

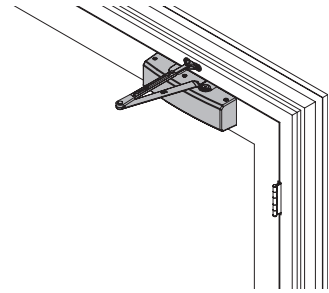

4050 Series

4050T Series - Surface Mount

4050T.....STD	\$490	N/A	N/A	15
4050T.....H	515	N/A	N/A	16
4050T.....BUMPER	500	N/A	N/A	15
4050T.....H BUMPER	525	N/A	N/A	16
4050T.....DE (Handed)	535	N/A	N/A	16
4050T.....DE H (Handed)	555	N/A	N/A	16
4050T.....DE BUMPER (Handed)	545	N/A	N/A	16
4050T.....DE H BUMPER (Handed)	565	N/A	N/A	16

Add for; Metal Cover (**MC**) (\$10), TORX Fasteners (**TORX**) (\$15), Special Rust Inhibitor (**SRI**) (\$40), Custom Powder Finish (**RAL**___) (\$40), Brite Metallic (**MTLPC**) (\$60).
For parts & accessories, see page 58.

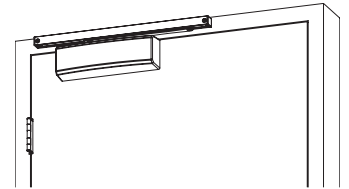

4050T Series

4110 Series - Surface Mount (Requires Handing)

4111 or 4116.....EDA	\$475	\$893	\$1,038	13
4111 or 4116.....EDA w/62G	480	898	1,043	13
4111 or 4116.....HEDA	507	921	1,068	13
4111 or 4116.....HEDA w/62G	512	926	1,073	13
4111 or 4116.....FL	611	NA	NA	15
4111 or 4116.....CUSH	507	921	1,068	13
4111.....HCUSH	565	977	1,130	14
4111 or 4116.....SCUSH	565	977	1,130	15
4111.....SHCUSH	618	1,030	1,174	15

Add for; Delay Action (**DEL**) (\$42) (4111 only), Advanced Variable Backcheck (**AVB**) (\$21), Telephone Cylinder (**TEL**) (\$42), Metal Cover (**MC**) (\$10), TORX Fasteners (**TORX**) (\$15), Special Rust Inhibitor (**SRI**) (\$40), Custom Powder Finish (**RAL**___)* (\$40), Brite Metallic (**MTLPC**)* (\$60)
Note - 4110 Series is available as 4111 (Adjustable 1-5) or 4116 (Size 6 Only - Not ADA Compliant).
For parts & accessories, see page 58.

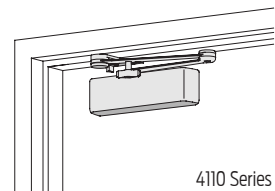

4110 Series

4110T Series - Surface Mount (Requires Handing)

4111T, 4113T-4114T.....STD	\$529	\$833	\$921	15
4111T, 4113T-4114T.....H	550	854	942	16
4111T, 4113T-4114T.....BUMPER	539	843	931	15
4111T, 4113T-4114T.....H BUMPER	561	865	953	16

Add for; Metal Cover (**MC**) (\$10), TORX Fasteners (**TORX**) (\$15), Special Rust Inhibitor (**SRI**) (\$40), Custom Powder Finish (**RAL**___)* (\$40), Brite Metallic (**MTLPC**)* (\$60)
For parts & accessories, see page 58.

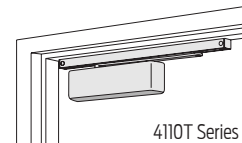

4110T Series

PARTS & ACCESSORIES

PRICE LIST

PARTS & ACCESSORIES	STANDARD POWDER COAT FINISHES	PLATED FINISHES		PARTS & ACCESSORIES	STANDARD POWDER COAT FINISHES	PLATED FINISHES		
	AL (689) DKBRZ (695) BRASS (696) LTBRZ (691) STAT (690) BLACK (693)				AL (689) DKBRZ (695) BRASS (696) LTBRZ (691) STAT (690) BLACK (693)	US26D	US 3 US 4 US 10	US 11 US 15 US 26

SEM7800 Series

SEM7810-E050	Extension 1/2"	21.00
SEM7810-E075	Extension 3/4"	28.00
SEM7810-E100	Extension 1"	31.00
SEM7810-E200	Extension 2"	37.00
SEM7810-E400	Extension 4"	40.00
SEM7810-514	Ball Pivot/Connection Link	31.00
SEM7820-515	Fastener Kit	63.00
SEM7820-72	Standard Cover & Base	474.00
SEM7820-825	Door Armature	126.00
SEM7820-516	Magnet Core Assembly	173.00
SEM7830-515	Fastener Kit	23.00
SEM7830-72	Standard Cover	95.00
SEM7830-268	Surface Mount Box	35.00
SEM7830-516	Magnet Core Assembly	159.00
SEM7830-825	Door Armature	126.00
SEM7840-515	Fastener Kit	23.00
SEM7840-72	Standard Cover	95.00
SEM7840-516	Magnet Core Assembly	159.00
SEM7840-825	Door Armature	125.00
SEM7850-515	Fastener Kit & Bracket	23.00
SEM7850-516	Magnet Core Assembly	159.00
SEM7850-72	Standard Cover	95.00
SEM7850-828	Door Armature	181.00

1250 Series

1250-3071	Std Cylinder Assy	135.00
1250-3077/PA	Reg Arm w/62PA	70.00
1250-3077/62A	Reg Arm w/62A	85.00
1250-3077L	Long Arm	70.00
1250-3049/PA	Hold Open Arm w/62PA	100.00
1250-3049L	Hold Open Long Arm	100.00
1250-3077EDA	EDA Arm	120.00
1250-3049EDA	HEDA Arm	155.00
1250-3077CUSH	CUSH Arm	155.00
1250-3049CUSH	HCUSH Arm	215.00
1250-3077SCUSH	S Cush Arm	215.00
1250-3049SCUSH	Spring H Cush Arm	275.00
1250-UNIV	Screw Pack	21.00
1250-TORX	Screw Pack	36.00
1250-TBTRX	Screw Pack	36.00
1250-72	Slim Cover	15.00
1250-18	Plate	42.00
1250-18PA	Plate	42.00
1250-30	Cush Shoe Support	21.00
1250-61	Spacer	23.00
1250-62A	Auxiliary Shoe	37.00
1250-62PA	PA Shoe	14.00
1250-146	Shaft Cover	4.00
1250-201	Spacer	4.00
1250-419	Panel Adapter	55.00
1250-3080	Spring CUSH Block	55.00
1250-Flat Box	Flat Box w/Label	4.00
1250-Instruction Sheet	Instruction Sheet	3.00
1250-Rebox Kit	Box & Instruction Sheet	5.00

1260 Series

1261-3071	Std Cylinder Assy	186.00
1260-3077	Reg Arm	80.00
1260-3077/PA	Reg Arm w/62PA	85.00
1260-3077/62A	Reg Arm w/62A	101.00
1260-3077L	Long Arm	85.00

1260-3049	Hold Open Arm	112.00
1260-3049/PA	Hold Open Arm w/62PA	117.00
1260-3049L	Hold Open Long Arm	117.00
1260-3077EDA	EDA Arm	138.00
1260-3077EDA/G	EDA Arm w/62G	144.00
1260-3049EDA	HEDA Arm	170.00
1260-3049EDA/G	HEDA Arm w/62G	176.00
1260-3077CUSH	CUSH Arm	170.00
1260-3049CUSH	HCUSH Arm	229.00
1260-72	Slim Cover	16.00
1260-SRT	Screw Pack	22.00
1260-TBSRT	Screw Pack	22.00
1260-WMS	Screw Pack	22.00
1260-TBWMS	Screw Pack	22.00
1260-TORX	Screw Pack	38.00
1260-TBTRX	Screw Pack	38.00
1260-18	Plate	45.00
1260-18PA	Plate	45.00
1260-18QF	Plate	45.00
1260-30	Cush Shoe Support	22.00
1260-37	Hold Open Stud	24.00
1260-41	Hold Open Nut	6.00
1260-45	Hold Open Shoe	22.00
1260-49	Hold Open Main Arm	58.00
1260-61	Spacer	24.00
1260-62A	Auxiliary Shoe	39.00
1260-62PA	PA Shoe	15.00
1260-77	Arm & Forearm	78.00
1260-78H	H Head & Tube	67.00
1260-78HL	Head & Long Tube	72.00
1260-79	Rod & Shoe	26.00
1260-79LR	Long Rod & Shoe	28.00
1260-83	Arm Screw	2.70
1260-83H	H Arm Screw	2.70
1260-146	Shaft Cover	4.30
1260-159	Arm Screw	2.70
1260-201	Spacer	4.30
1260-384	Stop	20.00
1260-419	Panel Adapter	59.00
1260-3048	Head & Tube Assy	76.00
1260-3048L	Head & Long Tube Assy	81.00
1260-Flat Box	Flat Box w/Label	4.30
1260-Instruction Sheet	Instruction Sheet	3.20
1260-Rebox Kit	Box & Instruction Sheet	5.00

1450 Series

1450-3071	Std Cylinder Assy	190.00	NA	NA
1450-3071DEL	Del Action Cylinder Assy	230.00	NA	NA
1450-3077/PA	Reg Arm w/62PA	70.00	NA	NA
1450-3077/62A	Reg Arm w/62A	85.00	NA	NA
1450-3077L	Long Arm	70.00	NA	NA
1450-3049/PA	H Arm w/62PA	100.00	NA	NA
1450-3049L	H Long Arm	100.00	NA	NA
1450-3077EDA	EDA Arm	120.00	NA	NA
1450-3077EDA/G	EDA Arm w/62G	125.00	NA	NA
1450-3049EDA	H EDA Arm	155.00	NA	NA
1450-3077CNS	Cush Arm	155.00	NA	NA
1450-3049CNS	H Cush Arm	215.00	NA	NA
1450-3077SCNS	S Cush Arm	215.00	NA	NA
1450-3049SCNS	Spring H Cush Arm	275.00	NA	NA
1450-72	Standard Cover	15.00	NA	NA
1450-72FC	Full Plastic Cover	25.00	NA	NA

1450 Series continued on next page

PARTS & ACCESSORIES

PRICE LIST

PARTS & ACCESSORIES	STANDARD POWDER COAT FINISHES AL (689) DKBRZ (695) BRASS (696) LTBRZ (691) STAT (690) BLACK (693)	PLATED FINISHES			PARTS & ACCESSORIES	STANDARD POWDER COAT FINISHES AL (689) DKBRZ (695) BRASS (696) LTBRZ (691) STAT (690) BLACK (693)	PLATED FINISHES		
		US26D	US 3 US 4 US 10	US 11 US 15 US 26			US26D	US 3 US 4 US 10	US 11 US 15 US 26
4040XP Series continued									
4040XP-83.....	Arm Screw	2.70			4040XPT-Rebox Kit.....	Box & Instruction Sheet	5.00		
4040XP-83H.....	H Arm Screw	2.70			4040SE Series				
4040XP-95.....	Arm Stud	13.00			4040SE-3071.....	Std Cylinder Assy	335.00		
4040XP-107CUSH.....	Metal Template	256.00			4040SE-3077T.....	Standard Arm	144.00	281.00	335.00
4040XP-107EDA.....	Metal Template	256.00			4040SE-3077DE.....	DE Arm	190.00	326.00	380.00
4040XP-107REG.....	Metal Template	256.00			4040SE-3038.....	Standard Track	367.00		
4040XP-107PA.....	Metal Template	256.00			4040SEL-3038SEL.....	Long Track	367.00		
4040XP-124.....	Plug	2.70			4040SE-72.....	Standard Cover	27.00		
4040XP-159.....	Arm Screw	2.70			4040SE-72MC.....	Metal Cover	37.00	202.00	250.00
4040XP-201.....	Spacer	4.30			4040SE-WMS.....	Screw Pack (inc. -81)	28.00	50.00	61.00
4040XP-384.....	Stop	20.00			4040SE-TBWMS.....	Screw Pack (inc. -81)	28.00	50.00	61.00
4040XP-419.....	Panel Adapter	59.00	152.00	169.00	4040SE-TORX.....	Screw Pack (inc. -81)	44.00	77.00	87.00
4040XP-3048.....	Head & Tube Assy	82.00			4040SE-TBTRX.....	Screw Pack (inc. -81)	44.00	77.00	87.00
4040XP-3048L.....	Head & Long Tube Assy	82.00			4040SE-18.....	Plate	58.00	197.00	237.00
4040XP-3080Spring Cush Block Assy (incl -58 & -80)		59.00			4040SE-18PA.....	Plate	58.00	197.00	237.00
4040XP-3107.....	Metal Template Set	1022.00			4040SE-31.....	Cover Screw	2.70		
4040XP-Flat Box.....	Flat Box w/Label	4.30			4040SE-59A.....	Cover Plate	5.00		
4040XP-Instruction Sheet.....	Instruction Sheet	3.20			4040SE-60.....	Cover Plate Screw	2.70		
4040XP-Rebox Kit.....	Box & Instruction Sheet	5.00			4040SE-61.....	Spacer	13.00		
4040XPT Series									
4040XPT-3071.....	Std Cylinder Assy	362.00			4040SE-73.....	End Cap	9.00		
4040XPT-3077T.....	Standard Arm	101.00	223.00	262.00	4040SE-78.....	Arm & Tube	69.00		
4040XPT-3077DE.....	DE Arm	144.00	273.00	310.00	4040SE-78DE.....	Main Arm & Tube	96.00		
4040XPT-3038.....	Standard Track	59.00			4040SE-81.....	Connector w/Ring	5.00		
4040XPT-3038B.....	Track w/Bumper	69.00			4040SE-82.....	Rod	58.00		
4040XPT-3038H.....	Track w/Hold Open	80.00			4040SE-83H.....	H Arm Screw	2.70		
4040XPT-3038HB.....	Track w/Hold Open & Bumper	91.00			4040SE-141.....	Plug	2.70		
4040XPT-72.....	Standard Cover	27.00			4040SE-141-1.....	Plug	2.70		
4040XPT-72MC.....	Metal Cover	37.00	202.00	250.00	4040SE-141-2.....	Plug	2.70		
4040XPT-SRT.....	Screw Pack (incl -3034)	49.00	71.00	83.00	4040SE-159.....	Arm Screw	2.70		
4040XPT-TBSRT.....	Screw Pack (incl -3034)	49.00	71.00	83.00	4040SE-425.....	Roller Lock Screw	4.30		
4040XPT-WMS.....	Screw Pack (incl -3034)	49.00	71.00	83.00	4040SE-3034SE.....	Track Roller with slider	32.00		
4040XPT-TBWMS.....	Screw Pack (incl -3034)	49.00	71.00	83.00	4040SE-3210.....	SE Transformer	69.00		
4040XPT-TORX.....	Screw Pack (incl -3034)	65.00	87.00	99.00	4040SE-3436.....	On/Off Switch Assy	70.00		
4040XPT-TBTRX.....	Screw Pack (incl -3034)	65.00	87.00	99.00	4040SE-Flat Box.....	Flat Box w/Label	4.30		
4040XPT-HSRT.....	HO Screw Pack (incl -3034H)	49.00	71.00	83.00	4040SE-Instruction Sheet.....	Instruction Sheet	3.20		
4040XPT-HTBSRT.....	HO Screw Pack (incl -3034H)	49.00	71.00	83.00	4040SE-Rebox Kit.....	Box & Instruction Sheet	5.00		
4040XPT-HWMS.....	HO Screw Pack (incl -3034H)	49.00	71.00	83.00	4040SEH Series				
4040XPT-HTBWMS.....	HO Screw Pack (incl -3034H)	49.00	71.00	83.00	4040SEH-3077SEH.....	SEH Arm	184.00	363.00	402.00
4040XPT-HTORX.....	HO Screw Pack (incl -3034H)	65.00	87.00	99.00	4040SEH-3038.....	Standard SEH Track	367.00		
4040XPT-HTBTRX.....	HO Screw Pack (incl -3034H)	65.00	87.00	99.00	4040SEH-59A.....	Cover Plate	5.00		
4040XPT-18.....	Plate	58.00	197.00	237.00	4040SEH-78SEH.....	Arm & Tube	130.00	255.00	285.00
4040XPT-18TJ.....	Plate	58.00	197.00	237.00	4040SEH-82SEH.....	Rod	92.00	204.00	218.00
4040XPT-31.....	Cover Screw	2.70			4040SEH-83SEH.....	Arm Screw	2.70		
4040XPT-54.....	Snap-On Cover Clip Only	10.00			4040SEH-3034SEH.....	Track Roller and Slider	32.00		
4040XPT-61.....	Spacer	13.00			4050 Series				
4040XPT-73.....	End Cap	9.00			4050-3071.....	Std Cylinder Assy	280.00		
4040XPT-78DE.....	Main Arm & Tube	96.00			4050-3071DEL.....	Delay Action Cylinder	320.00		
4040XPT-82.....	Rod	58.00			4050-3077/PA.....	Reg Arm w/62PA	125.00		
4040XPT-83H.....	H Arm Set Screw	2.70			4050-3077/62A.....	Reg Arm w/62A	145.00		
4040XPT-141-1.....	Plug	2.70			4050-3077L.....	Long Arm	125.00		
4040XPT-141-2.....	Plug	2.70			4050-3049/PA.....	H Arm w/62PA	166.00		
4040XPT-159.....	Arm Screw	2.70			4050-3049L.....	H Long Arm	166.00		
4040XPT-169.....	Bumper Assy	20.00			4050-3077EDA.....	EDA Arm	155.00		
4040XPT-425.....	Roller Lock Screw	4.30			4050-3077EDA/G.....	EDA Arm w/62G	161.00		
4040XPT-3034.....	Track Roller	27.00			4050-3049EDA.....	H EDA Arm	185.00		
4040XPT-3034H.....	Hold Open Track Roller	27.00			4050-3049EDA/G.....	H EDA Arm w/62G	190.00		
4040XPT-3054.....	Hold Open Clip	28.00			4050-3077CNS.....	Cush Arm	185.00		
4040XPT-Flat Box.....	Flat Box w/Label	4.30			4050-3049CNS.....	H Cush Arm	245.00		
4040XPT-Instruction Sheet.....	Instruction Sheet	3.20			4050-3077SCNS.....	S Cush Arm	245.00		

4050 Series continued on next page

PARTS & ACCESSORIES

PRICE LIST

PARTS & ACCESSORIES	STANDARD POWDER COAT FINISHES	PLATED FINISHES			PARTS & ACCESSORIES	STANDARD POWDER COAT FINISHES	PLATED FINISHES		
	AL (689) DKBRZ (695) BRASS (696) LTBRZ (691) STAT (690) BLACK (693)	US26D	US 3 US 4 US 10	US 11 US 15 US 26		AL (689) DKBRZ (695) BRASS (696) LTBRZ (691) STAT (690) BLACK (693)	US26D	US 3 US 4 US 10	US 11 US 15 US 26
<i>4050 Series continued</i>									
4050-3049SCNS.....Spring H Cush Arm	305.00				4050T-480.....Shaft Extender	51.00			
4050-D Rw/pA.....Reg arm w/62PA for Delay	125.00				4050T-3034.....Track Roller	27.00			
4050-D Hw/PA.....H Arm w/62PA for Delay	166.00				4050T-3034H.....Hold Open Track Roller	27.00			
4050-62DAPA.....PA shoe for Delay	15.00				4050T-3054.....Hold Open Clip	28.00			
4050-31.....Cover Screw	2.70				4050T-Flat Box.....Flat Box w/Label	4.30			
4050-72.....Standard Cover	27.00				4050T-Instruction Sheet.....Instruction Sheet	3.20			
4050-72ALT.....Alternative cover	27.00				4050T-Rebox Kit.....Box & Instruction Sheet	5.00			
4050-72MC.....Metal Cover	37.00								
4050-SRT.....Screw Pack	22.00				4110 Series				
4050-TBSRT.....Screw Pack	22.00				4111(6)-3071.....Std Cylinder Assy	323.00			
4050-WMS.....Screw Pack	22.00				4111(6)-3071AVB.....AVB Cylinder Assy	344.00			
4050-TBWMS.....Screw Pack	22.00				4111-3071DEL.....Delay Action Cylinder Assy	365.00			
4050-TORX.....Screw Pack	38.00				4111(6)-3071TEL.....TEL Cylinder Assy	365.00			
4050-TBTRX.....Screw Pack	38.00				4110-3077EDA.....EDA Arm	125.00	368.00	465.00	
4050-18.....Plate	58.00				4110-3077EDA/G.....EDA Arm w/62G	130.00	373.00	470.00	
4050-18G.....Plate	58.00				4110-3049EDA.....H EDA Arm	157.00	396.00	495.00	
4050-18PA.....Plate	58.00				4110-3049EDA/G.....H EDA Arm w/62G	162.00	401.00	500.00	
4050-30.....Cush Shoe Support	22.00				4110-3077CNS.....Cush Arm	157.00	396.00	495.00	
4050-61.....Spacer	24.00				4110-3049CNS.....H Cush Arm	215.00	452.00	557.00	
4050-62A.....Auxiliary Shoe	39.00				4110-3077SCNS.....S Cush Arm	215.00	452.00	557.00	
4050-62PA.....PA Shoe	15.00				4110-3049SCNS.....Spring H Cush Arm	268.00	505.00	601.00	
4050-419.....Panel Adapter	59.00				4110-3049FL.....FL Arm	261.00			
4050-3080.....Spring Cush Block Assy (incl -58 & -80)	59.00				4110-72.....Standard Cover	27.00			
4050-Flat Box.....Flat Box w/Label	4.30				4110-72MC.....Metal Cover	37.00	202.00	250.00	
4050-Instruction Sheet.....Instruction Sheet	3.20				4110-SRT.....Screw Pack	22.00	44.00	55.00	
4050-Rebox Kit.....Box & Instruction Sheet	5.00				4110-TBSRT.....Screw Pack	22.00	44.00	55.00	
					4110-WMS.....Screw Pack	22.00	44.00	55.00	
					4110-TBWMS.....Screw Pack	22.00	44.00	55.00	
					4110-TORX.....Screw Pack	38.00	71.00	81.00	
					4110-TBTRX.....Screw Pack	38.00	71.00	81.00	
					4110-18.....Plate	58.00	197.00	237.00	
					4110-18CUSH.....Plate	58.00	197.00	237.00	
					4110-28.....Fusible Link	11.00			
					4110-30.....Cush Shoe Support	22.00	64.00	79.00	
					4110-31.....Cover Screw	2.70			
					4110-37.....Hold Open Stud	24.00			
					4110-41.....Hold Open Nut	6.00			
					4110-48.....Hold Open Forearm	65.00			
					4110-49FL.....FL Main Arm & Rod	61.00			
					4110-58.....Spring & Screw (used with -80)	11.00			
					4110-61.....Spacer	24.00	66.00	82.00	
					4110-62FL.....PA-FL Shoe	15.00			
					4110-77EDA.....Main Arm	114.00			
					4110-80.....Block (used with -58)	49.00			
					4110-107 EDA.....Metal Template	256.00			
					4110-107 CUSH.....Metal Template	256.00			
					4110-3107.....Metal Template	511.00			
					4110-159.....Arm Screw	2.70			
					4110-201.....Spacer	4.30			
					4110-3048.....FL Forearm				
					4110-3080.....Spring Cush Block (incl -58 & -80)	59.00			
					4110-419.....Panel Adapter	59.00	152.00	169.00	
					4110-Flat Box.....Flat Box w/Label	4.30			
					4110-Instruction Sheet.....Instruction Sheet	3.20			
					4110-Rebox Kit.....Box & Instruction Sheet	5.00			
					4110T Series				
					4111(3,4)T-3071.....Std Cylinder Assy	349.00			
					4110T-3077T.....Standard Arm	94.00	223.00	263.00	
					4110T-3038.....Standard Track	59.00			
					4110T-3038B.....Track w/Bumper	69.00			
					4110T-3038H.....Track w/Hold Open	80.00			

4110T Series continued on next page